

:
:
:

0632-4426094

277000

0632-4426094

277000

2012 9 28
1000 1680 2 5.5
2 6.25
210 14.5 3.7 10 5.5
140 / 190 /
2× 18MW

GB16171-2012 2

GB18918-2002 A

RO SRO

SRO

2020 8

2019 12 10

2019-370403-25-03-081944

2018 9

2019 9 25

2019 9 16

2020 8 14

2020 B-45

2020 7

2020 8

MVR

2020 10

2022 1

2022 3

2022 3 4

2022 3 5

()

2017 4

2022 3 8 10

()

HJ S 2022 0308001

()

	
	
	- 1 -
	- -
2.1	- 5 -
2.2	- 6 -
2.3	- 7 -
2.4	- 8 -
2.5	- 9 -
2.6	- 11 -
	- 1 -
3.1	- 14 -
3.2	- 19 -
3.3	" "	- 20 -
	- 21 -
4.1	()	- 21 -
4.1.1	- 21 -
4.1.2	- 23 -
5	- 23 -
4.2	- 23 -
	- 2 -
	- 24 -
5.1	- 24 -
5.2	- 25 -
5.3	- 25 -

5.3.1	- 25 -
5.3.2	- 26 -
5.3.3	- 26 -
	- 2 -
6.1	- 29 -
	- 0 -
7.1	- 30 -
7.2	- 30 -
	- -

" "

- 1
- 2
- 3
- 4
- 5
- 6
- 7
- 8

()

)	
6.		(2020.4.29
2020	9 1)	
7.	<	>
	2017 682	
8.		
9.		
	2018.5.15	
10.		
	2020 688 2020.12.13	
11.		2017 4
12.		
	(2020 3	
)	
13.		(
	2020 B-45)	
14.		
	2020.8	
15.		

1

(DB 37/3161-2018) 2

1-1

1-1

1.0 / 3

1.0 / 3

0.03

			/L	5
	COD		/L	
	BOD ₅		/L	10
			/L	10
			/L	250
			/L	0.3
3	(GB 12348-2008) 3 1-3 B(A)			
		3	65	55
4	(GB18599-2020) GB18597-2001			

N 34. 862799° , E 117. 443783°

800

1

2

3

1600
2400

1600
2400

100%
100%

NWR

2-1

2-1

		1400 ²	1400 ²	MVR
			1400 ²	

L LTETM

MVR

2-2

2-2

	AER				
1	AER	Q=35 ³ / 2100 10500	2	2	
2	AER	1000 V =1 ³	1	1	
3	AER	V=1 ³	1	1	
4	AER	V=20 ³	1	1	
5	AER	Q=5 ³ / H=15	1	1	
6	AER	Q=20 ³ / H=25 50	1	1	
7	AER	= 120 /	1	1	
8		1000 2000	2	2	
9		Q=25 ³ / H=50	2	2	
10		V=20 ³	1	1	
11		V=1 ³	1	1	
12		V=1 ³	1	1	
13		Q=5 ³ / H=15	1	1	
14		Q=5 ³ / H=15	1	1	
15	AER	V=30 ³	1	1	
1		1800 3000 8 10 11.5 14000 / 180 / 0.1 /	3	3	
2		2.5	1	1	
3		2.5	1	1	
4		Q=12 / ,H=40 SUS304	2	2	
5		Q=5 / ,H=35	2	2	
	SRO				
1	RO	Q=70 ³ / H=40	2	2	
2	RO	70 ³ /	2	2	

3	RO	Q=85 ³ / H=460	2	2	
4		Q=45 ³ / H=40	2	2	
5	RO	70 ³ / , 0 70% 6 1000PSI 10:6	2	2	
6	RO	Q=10L/ H=0.3MP	1	1	
7		Q=20L/ H=0.3MP	1	1	
SRO					
1		V=64 ³ 4000 4000 4000	1	1	
2		Q=24 ³ / H=40	1	1	
3		30 ³	1	1	
4		30 ³	1	1	
5		1 ³	1	1	

2-2 MVR

1		4KW 63 /	0	1	
2		800W 15600 18176 :40970	0	1	
3		800W 56A 50H	0	1	
4		5 100	0	1	
5		45 :10MP 100	0	1	
6		100L/ 0.5 0.1	0	1	
7		0.4MP 2X4 6 / 0.97	0	1	
8		:59 / 44	0	2	
9		30-80 / 1500 / 2MP	0	1	
10	750	: 0.22 750 105	0	2	
11		:1.3MP 72 1.0MP	0	1	
12		2 0.6MP	0	1	
13		:1.0MP 4	0	2	
14		80 10	0	1	
15		5 TA2	0	1	
16		PPH 80	0	1	
17		1.0MP :3	0	1	

2.

2-3

2-3

1			/	19.6	6.9
2			/	0.17	0.1
3			/	135	230
4			/	157.5	140
5	N ₂ CO ₃		/	65.7	66
6		/	/	427	460

2.

1

1

20 /

2

RO

51100 /

43800 /

7300 /

3

2-1

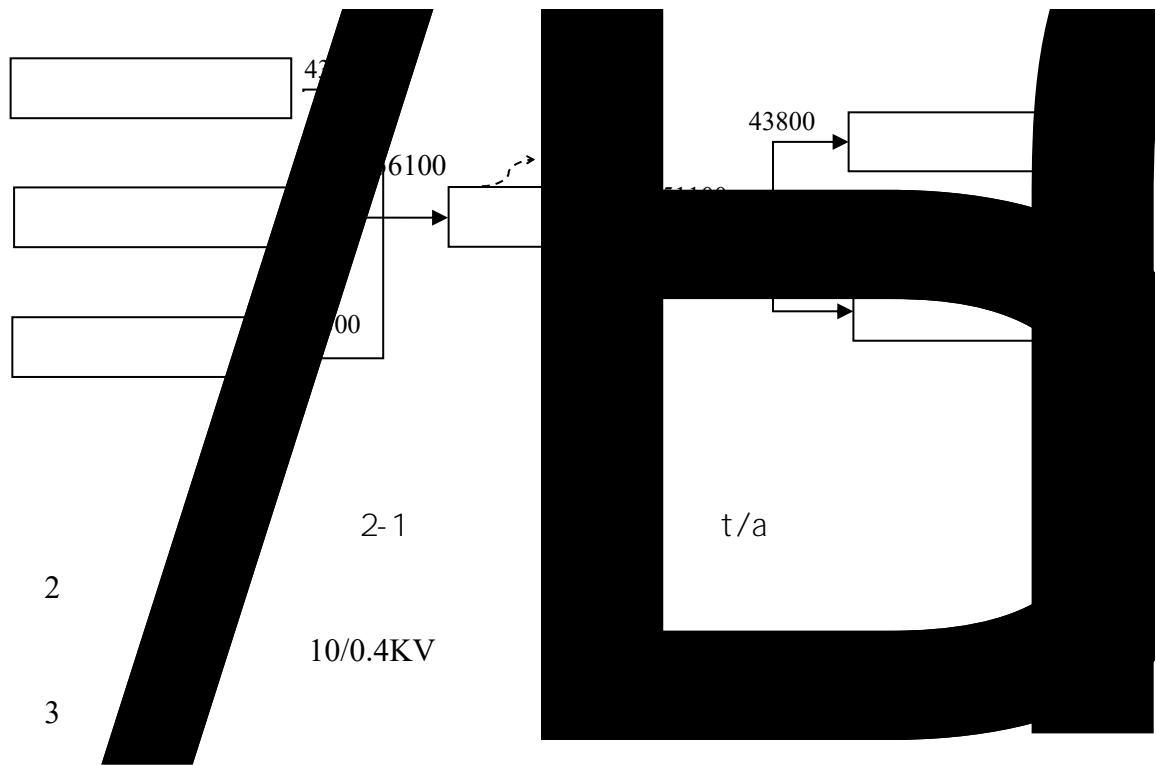

2.

1

160^{3/}

L LEMTM

RO

RO

2

RO

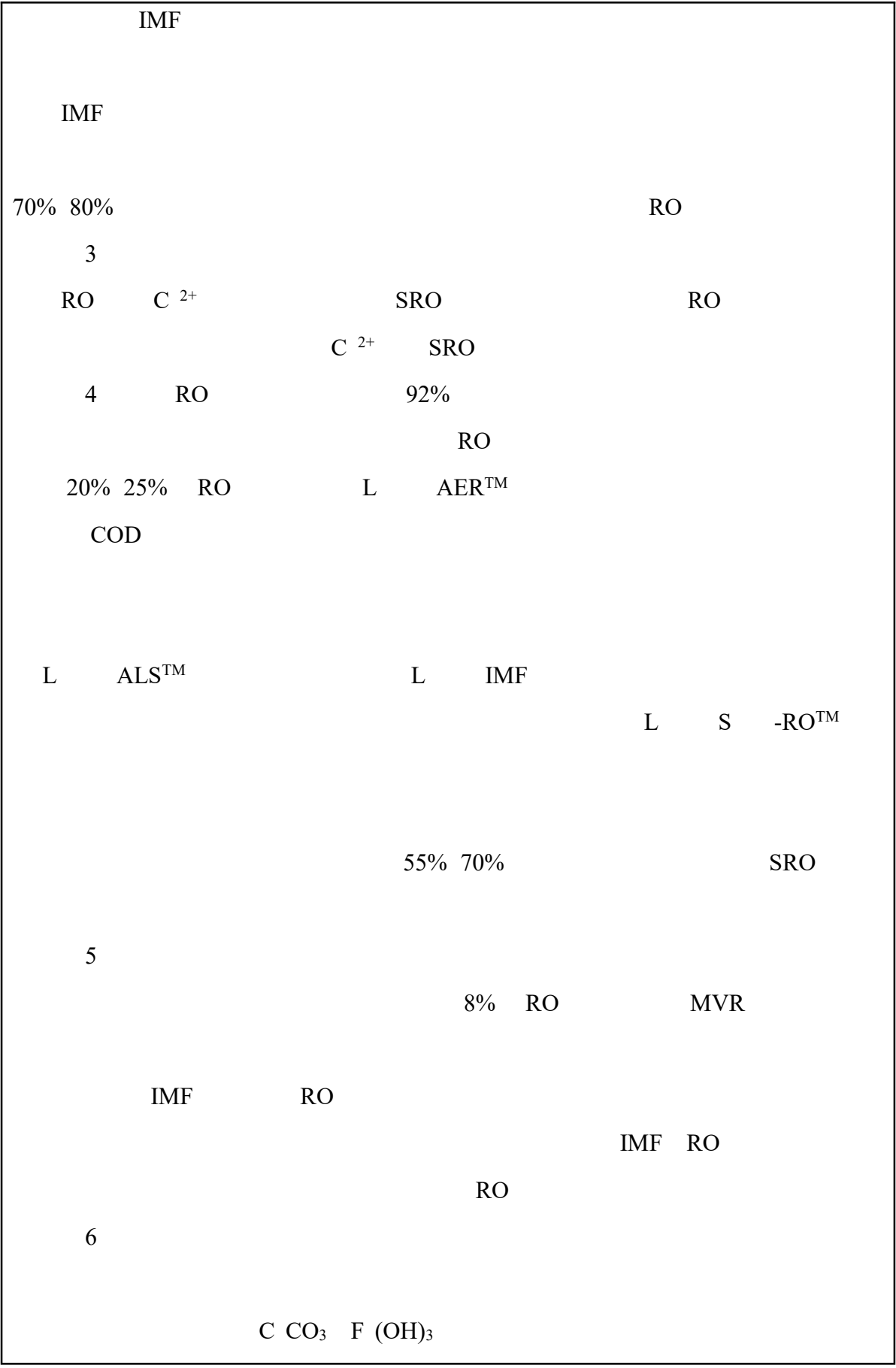

2-2

(1)

H₂S NH₃

COD

(2)

SRO

RO/SRO

SRO

(3)

65 85 B(A)

(4)

MVR

MVR

2020 688

10%

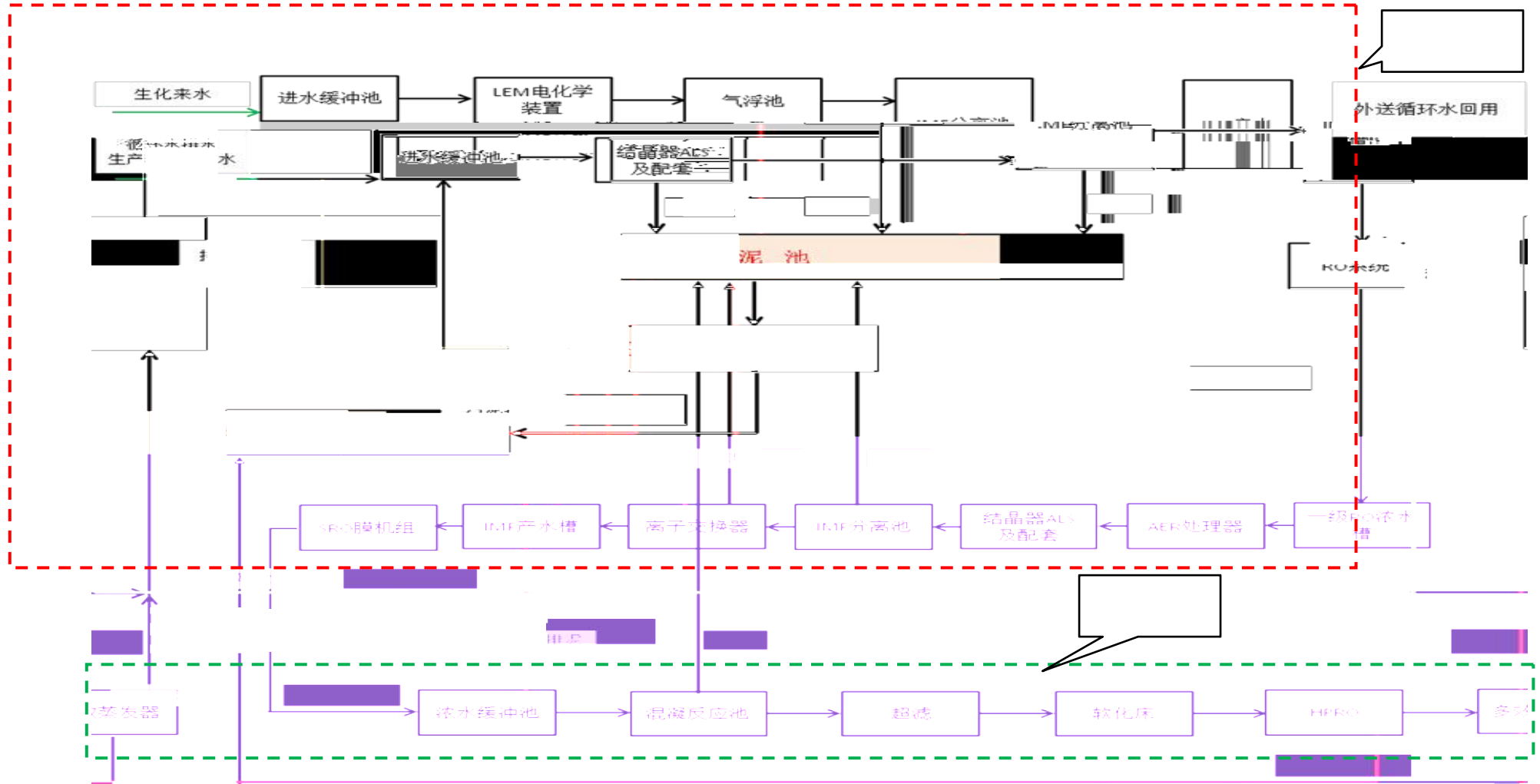

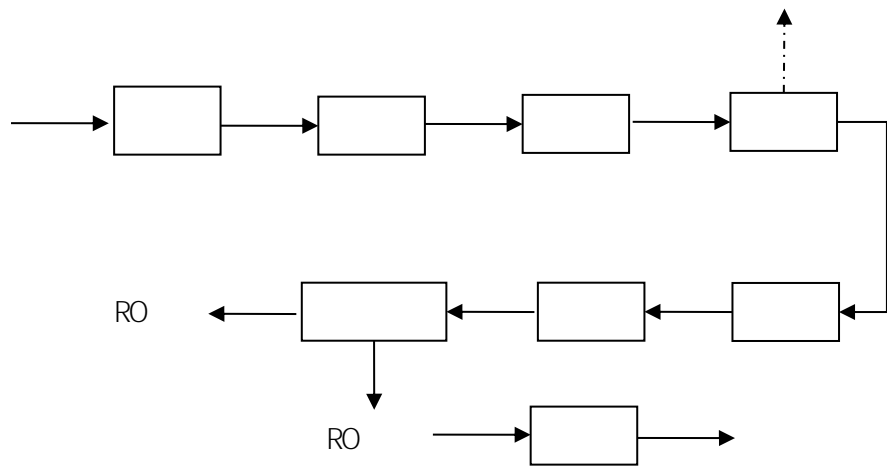

3.1.1

SRO

RO/SRO

SRO

MVR

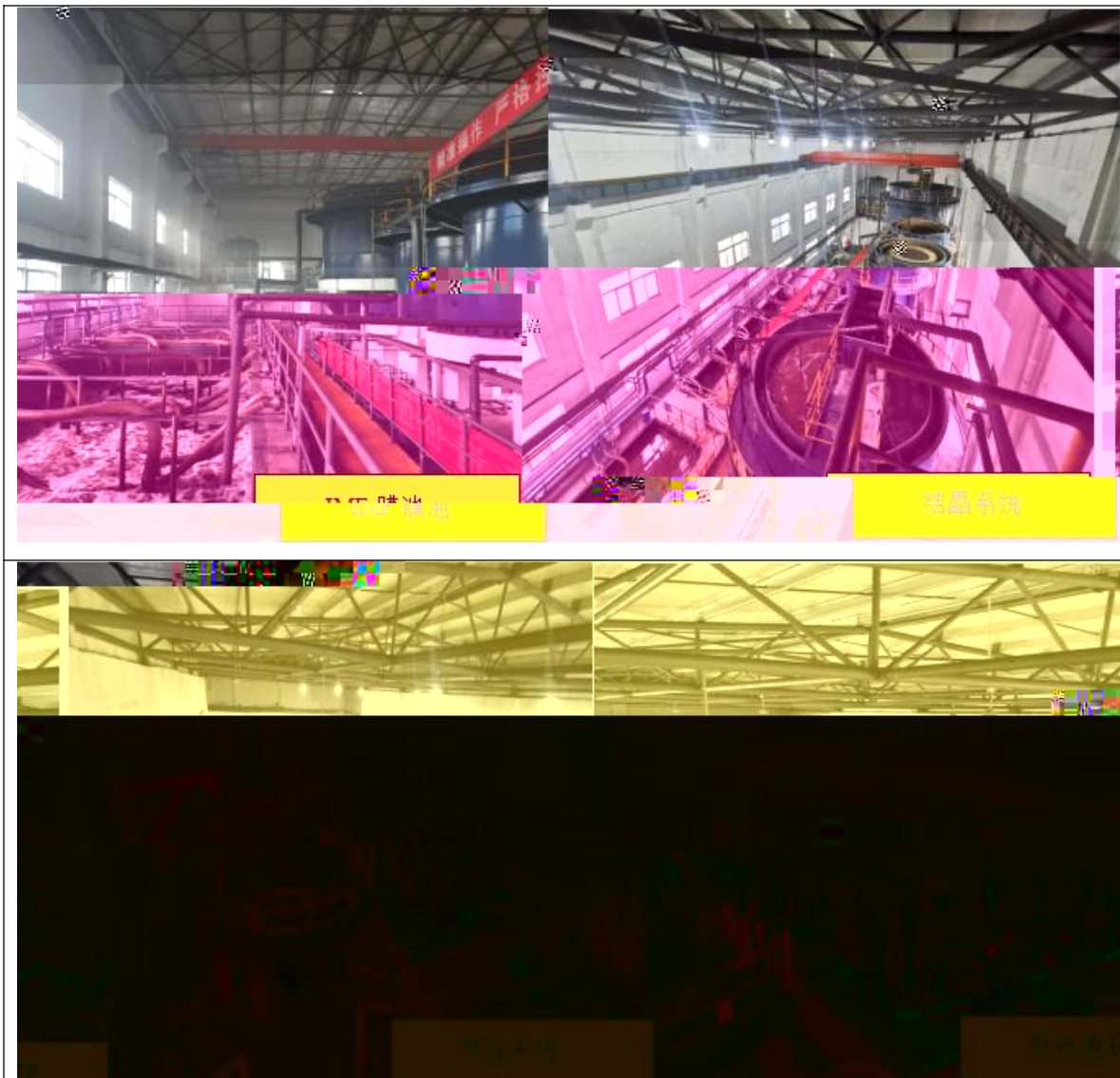

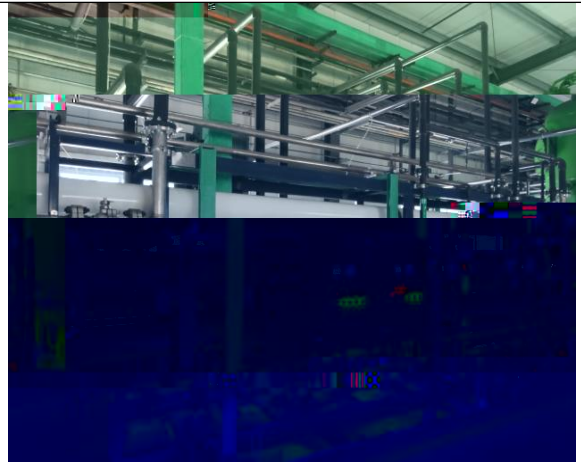
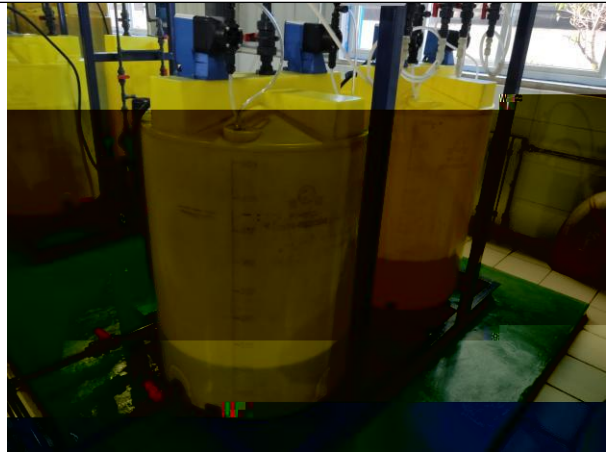
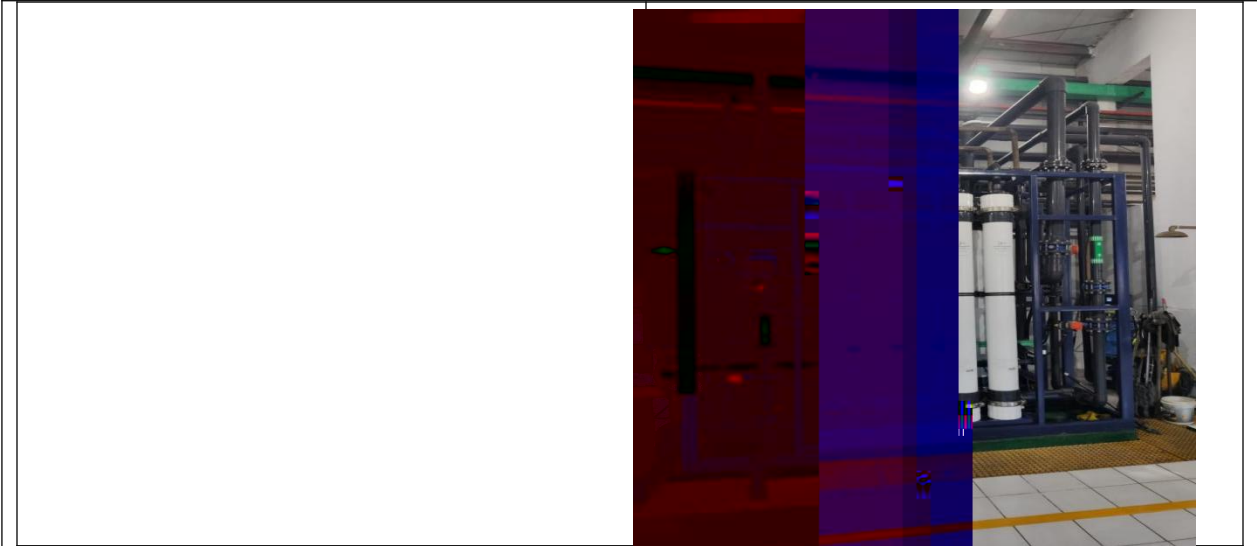

RO



MVR

3. 1. 2

H₂S

NH₃

COD

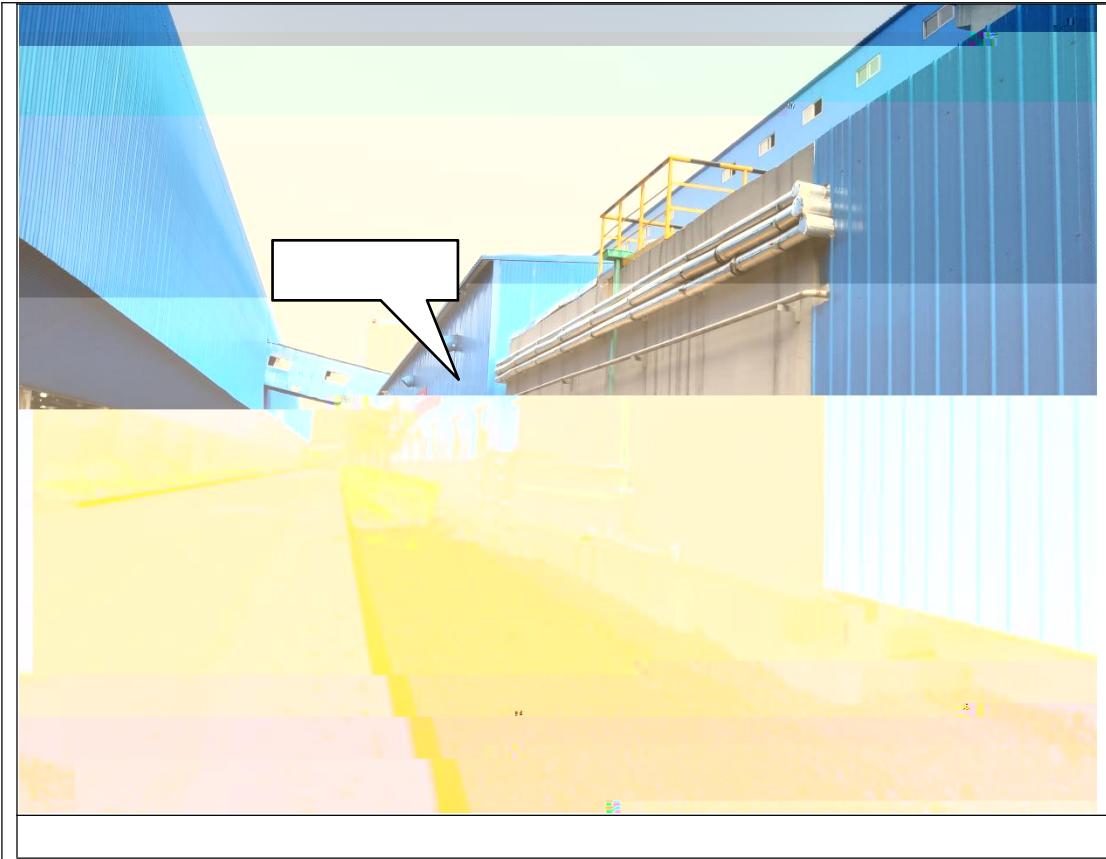

3.1.3

- 1
- 2
- 3

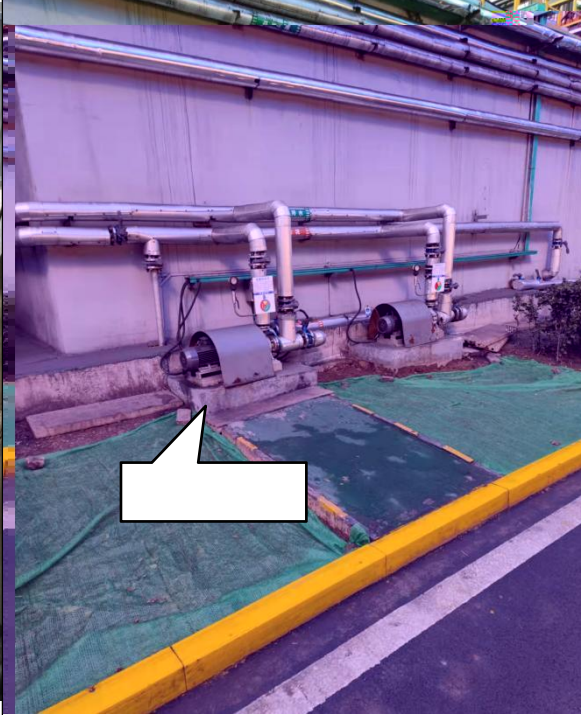

3.1.4

6000 /



-1

1		6000 /			

1

(370403-

2021-45M)

2

RO

.1.1

1

1600

880 ²

80 ^{3/}

160 ^{3/}

60 ^{3/}

RO

40 ^{3/}

RO

92% 340 /

2

3

2019

2

4

1

GB3095-2012

2

GB3838-2002

GB/T14848-2017

3

GB3096-

2008 3

5

1

DB37/3161-

2018 2

2

RO

RO

3

65 B(A) 55 B(A)

GB12348 2008 3

4

GB18599--2001

GB18597-

2001

.1.2

1

2

3

4

5

.2

2019 9 16

2020 8 14

(2020 B-45)

.1

()

5-1

5-2

5-1

	H	HJ 1147-2020 H	/
		GB/T 11901-1989	4 /L
		HJ 828-2017	4 /L
		HJ 505-2009	0.5 /L
		HJ 535-2009	0.025 /L
		GB/T 11893-1989	0.01 /L
		GB/T 5750.4-2006	/
		HJ 84-2016	0.007 /L
		HJ 84-2016	0.018 /L
	C CO ₃	GB/T 7477-1987 EDTA	/
	C CO ₃		/
		GB/T 13200-1991	1
			/
		GB/T 11911-1989	0.03 /L
		HJ 533-2009	0.01 / ³
			0.001 / ³

		HJ/T 32-1999 4-	0.003 / 3
		GB/T 14675-1993	/

5-2

1	H	A1611HJ286		2021.7.1- 2022.6.30
2	BSA224S	A1611SP023		2021.7.23- 2022.7.22
3		1801		2020.5.29- 2023.5.28
4	BSC-150	A1611SP016		2021.7.27- 2022.7.26
5	721	A1611HJ141		2021.11.10- 2022.11.9
6	BSA224S	A1611SP023		2021.7.23- 2022.7.22
7	ICS-600	A1611SP033		2021.11.10- 2022.11.9
8	CE 3500	A1611SP032		2021.11.10- 2022.11.9
9	AWA6228+	A1611HJ359		2021.9.17- 2022.9.16

.2

5.3.1

1

2

3

5.3.2

()

(1)

(2)

(3)

(HJ/T 91.1-2019)

(4)

5.3.3

(1)

(GB12348 -2008)

(2)

(3)

(4)

1.7-3.0 / 5 /

(5)

0.5 B

5-3 ()

					(%)	
		(/ ³)	(/ ³)	(%)		
	FS220307013-4	24.2	24.2	0	10	
	FS220307014	24.2				
COD	FS220307013-4	36	36	1.37	10	
	FS220307014	37				

	FS220307013-4	3.21	3.25	1.23	10	
	FS220307014	3.29				
	FS220307013-4	0.03L	0.03L	0	10	
	FS220307014	0.03L				
	FS220308013-4	24.0	24.0	0.21	10	
	FS220308014	24.1				
COD	FS220308013-4	39	38	1.30	10	
	FS220308014	38				
	FS220308013-4	4.40	4.42	0.45	10	
	FS220308014	4.44				
	FS220308013-4	0.03L	0.03L	0	15	
	FS220308014	0.03L				
	FQ220307052	ND(/ ³)	ND(/ ³)	0	10	
	FQ220307067	ND(/ ³)				
	FQ220307056	ND(/ ³)	ND(/ ³)	0	10	
	FQ220307068	ND(/ ³)				
	FQ220308052	ND(/ ³)	ND(/ ³)	0	10	
	FQ220308067	ND(/ ³)				
	FQ220308056	ND(/ ³)	ND(/ ³)	0	10	
	FQ220308068	ND(/ ³)				
	FS220307013-4	12.5	12.5	0	10	
	FS220307014	12.5				
	FS220308013-4	12.7	12.7	0	10	
	FS220308014	12.7				

		/L	/L	/L	/L	
	K220309001	7.70	7.68	0.02	0.35	
	K220309002	0.338	0.348	0.010	0.015	
	K220310001	281	281	0	8	
	K220310002	19.7	19.9	0.2	1.0	
COD	K220310003	34	35.5	0.5	3.2	

		B(A)	B(A)	B(A)	B(A)	B(A)	
2022.3.8	AWA6228+ AWA6021A	94.0	94.0	93.8	0.2	± 0.5	
2022.3.8	AWA6228+ AWA6021A	94.0	94.0	93.8	0.2	± 0.5	
2022.3.9	AWA6228+ AWA6021A	94.0	94.0	93.8	0.2	± 0.5	
2022.3.9	AWA6228+ AWA6021A	94.0	94.0	93.8	0.2	± 0.5	

6.1.1

6-1

RO	H	C ⁻	4 / 2
RO	PH	C ⁻ BOD ₅	

6.1.2

6-2

1#		H ₂ S	2 / 4
2#-4#			

6.1.3

6-3

6-3

		1 / 2	

.1

7-1

7-1

2022.3.8	260 ^{3/}	221 ^{3/}	85%
2022.3.9		226 ^{3/}	87%
2022.3.10		210 ^{3/}	81%

.2

7.2.1

1

7-2 7-3

7-1

)	P		/	
2022.3.8	10:32	15.1	100.8	S	3.4	
	12:09	16.4	100.7	S	2.8	
	13:50	18.2	100.6	S	3.0	
	15:22	18.8	100.6	S	2.7	
2022.3.9	10:11	17.1	101.2	S	3.0	
	11:29	18.5	101.1	S	3.5	
	13:00	20.2	101.0	S	2.6	
	14:06	20.7	101.0	S	2.9	

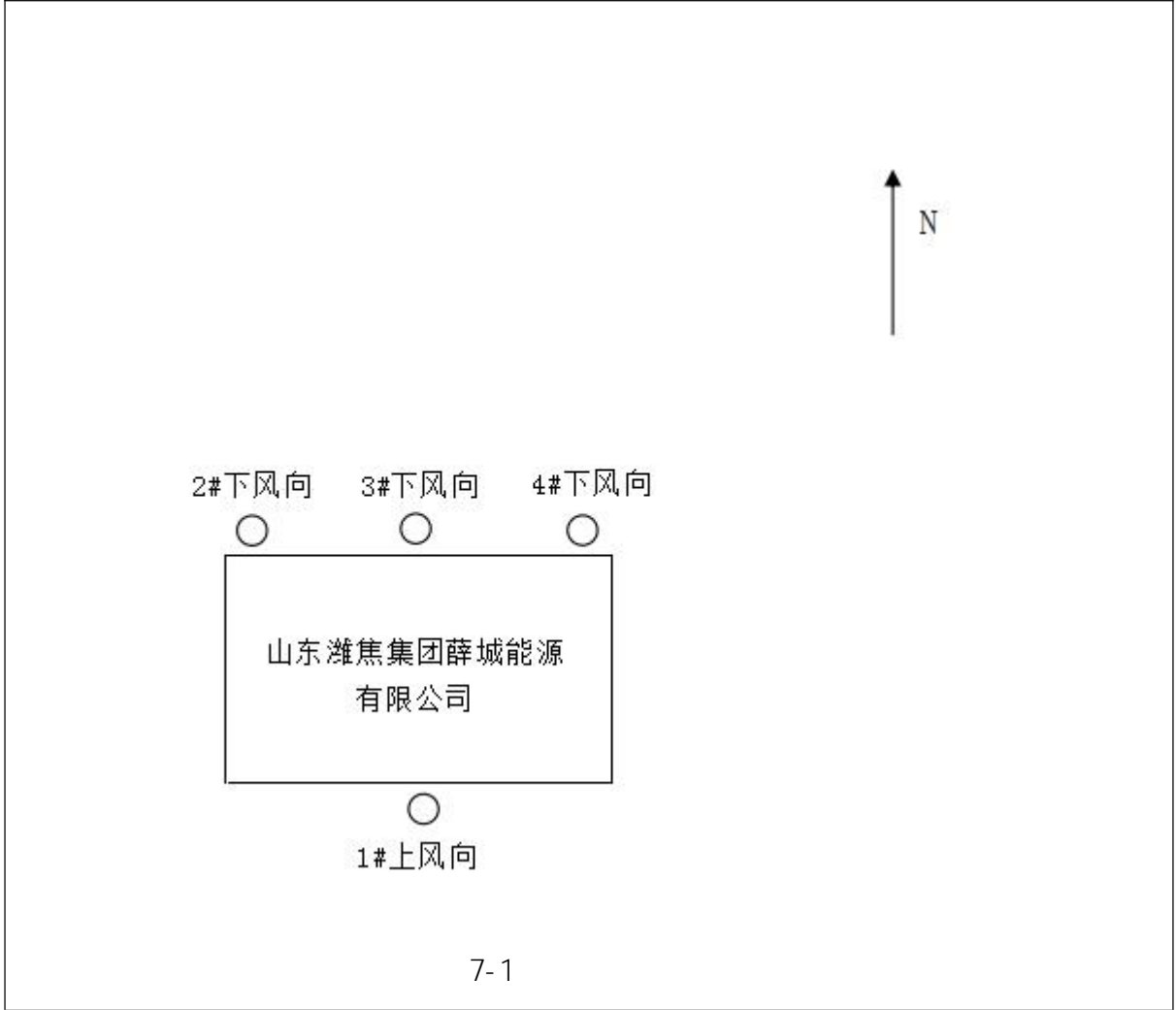

7-3

2022.3.8	/ 3	1#	ND	ND	ND	ND	0.02	
		2#	ND	ND	ND	ND		
		3#	ND	ND	ND	ND		
		4#	ND	ND	ND	ND		
2022.3.9		1#	ND	ND	ND	ND		
		2#	ND	ND	ND	ND		
		3#	ND	ND	ND	ND		
		4#	ND	ND	ND	ND		
2022.3.8	1#	10	10	10	10	20		
	2#	12	11	11	13			

		3#	11	12	11	11	
		4#	13	11	12	13	
		1#	10	10	10	10	
2022.3.9		2#	11	12	12	11	
		3#	12	13	11	12	
		4#	11	12	13	11	
		1#	0.001	ND	0.002	ND	
2022.3.8		2#	0.003	ND	0.005	0.001	
		3#	0.012	0.017	0.012	0.016	
		4#	0.009	0.015	0.011	0.013	
	/ 3	1#	ND	0.001	ND	0.002	0.03
2022.3.9		2#	0.006	0.004	0.002	0.005	
		3#	0.014	0.013	0.019	0.017	
		4#	0.010	0.010	0.016	0.015	
		1#	0.07	0.08	0.09	0.08	
2022.3.8		2#	0.08	0.09	0.10	0.09	
		3#	0.10	0.11	0.11	0.10	
		4#	0.09	0.09	0.10	0.10	
	/ 3	1#	0.08	0.08	0.08	0.08	1.0
2022.3.9							2

			/L	3.71 10 ⁴	3.73 10 ⁴	3.74 10 ⁴	3.72 10 ⁴		
		C ⁻	/L	1.62 10 ⁴	1.64 10 ⁴	1.56 10 ⁴	1.63 10 ⁴		
			/L	1.50 10 ⁴	1.51 10 ⁴	1.42 10 ⁴	1.48 10 ⁴		
		C CO ₃	/L	229	235	231	247		
		C CO ₃	/L	1.24 10 ³	1.27 10 ³	1.22 10 ³	1.29 10 ³		
				7	8	10	10		
			/L	6.38	6.56	6.54	6.59		
2022.3.10	RO	H		9.7 22.1	9.6 22.1	9.6 22.7	9.6 23.3		
			/L	3.72 10 ⁴	3.73 10 ⁴	3.71 10 ⁴	3.74 10 ⁴		
		C ⁻	/L	1.60 10 ⁴	1.65 10 ⁴	1.59 10 ⁴	1.61 10 ⁴		
			/L	1.46 10 ⁴	1.49 10 ⁴	1.45 10 ⁴	1.41 10 ⁴		
		C CO ₃	/L	241	237	233	246		
		C CO ₃	/L	1.25 10 ³	1.28 10 ³	1.23 10 ³	1.29 10 ³		
				8	9	9	10		
			/L	7.37	7.20	7.23	7.28		
7-5 RO									
			/L						
2022.3.9	RO	H		8.4	8.2	8.3	8.3	8.2-8.4	6.5-8.5
				12	16	10	15	13	30
				38	35	37	36	36	60
				7.0	7.2	7.2	7.1	7.1	10
				3.50	4.12	2.99	3.25	3.46	10
				0.04	0.06	0.05	0.08	0.06	1
				568	572	609	558	577	1000
				26.7	28.3	24.4	24.2	25.9	250
				12.9	14.3	12.6	12.5	13.1	250
		C CO ₃		32	35	36	34	34	450
		C CO ₃		71	76	80	73	75	350
				2	2	1	3	2	5
		/		200	341	243	240	256	
				ND	ND	ND	ND	ND	0.3
2022.3.10	RO	H		8.1	8.3	8.1	8.2	8.1-8.3	6.5-8.5

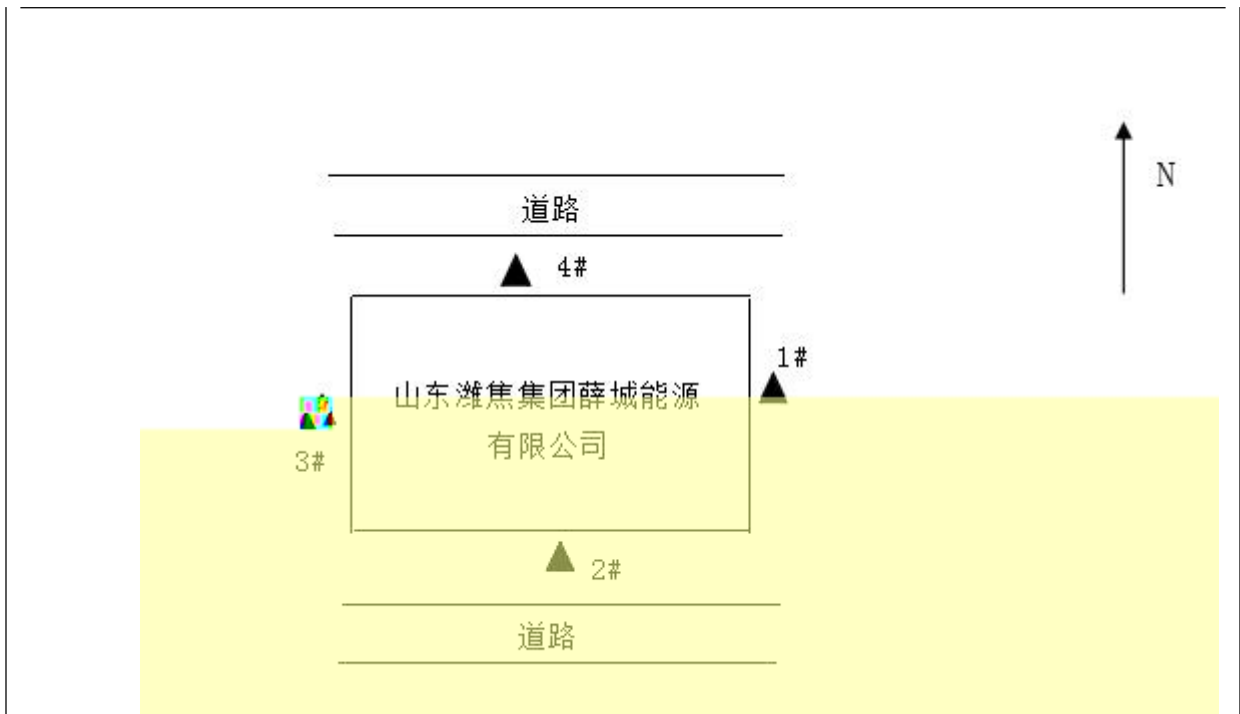

53 64

47 55

(GB12348-2008) 3

7.2.4

VOCs

7.3

7-7

1	DB37/3161-2018) 2	(GB14554-1993) 1 2018) 2	(GB 37/3161-

2	RO GB/T19923-2005)	RO (GB/T 19923-2005)	
3	GB12348-2008) 3	(GB12348-2008) 3	
4	2001) GB18599- GB18597-2001)		
5			
6			

				2400				
300								
2277600								
8.1								
							0.019 / 3	
0.12 / 3				13				
	(GB14554-1993)	1						
					(DB 37/3161-2018)	2		
			RO					H(8.1-8.4)
3.53 /L			38 /L		0.06 /L		413 /	
75 /L	25.9 /L		14 /L		13.1 /L		2	
34 /L			581 /L	BOD ₅ 7.2 /L				
			(GB/T 19923-2005)					
		53	64			47	55	
						(GB12348-2008)	3	
8.2								
RO					RO			